



CM48 Series

IR Illuminator



CaMate

Continuous Variable Angle Technology · Adjustable Beam Angle · High Uniformity

CaMate CM48 is a series of professional IR illuminators designed with VIVOTEK's Continuous Variable Angle Technology (CVA Tech), providing highly efficient intensity and uniform distribution to fit 10° ~ 180° FOV via adjustable beam angles up to 250 meters. The series offers multiple options for outdoor and long-distance in many applications such as traffic LPR/ANPR, airports, parking lots and many more.

The CM48 series delivers accurate image quality with special beam pattern designs such as circular (-1040), elliptical (-2040/4080) and rectangular (-90120/180), as well as 180° illumination for panoramic Multiple-sensor solutions (-180), providing high intensity and uniformity without hot spots or overexposure issues. The radiant power of the LED's are effectively projected on to the surveillance area. All ranges of

variable angles can maintain highly efficient functionality while also conserving energy.

Thanks to CVA Tech, this series can adjust beam angles according to different installation distances, which make it easy to install. Further, an optional remote control provides users quick and easy to set-up the IR LED from the ground site. To meet the demands of different scenarios, the CM48 series is compatible with a variety of accessories, such as brackets, wall mounts and alignment tools. With the added support and flexibility of an abundance of accessories, the CM48 series is an excellent intelligent IR illuminator for optimizing your video performance in dark or low-light surveillance.

Key Features

- Continuous Variable Angle Technology (CVA Tech)
- Variable Field of View 10° ~ 180°
- Adjustable Beam Angle up to 250 Meters
- High Uniformity without Hot Spots and Overexposure
- Accurate Image Quality with Special Beam Patterns for Different Solutions: Circular, Elliptical and Rectangular
- Extreme Weather Support
- Weather-proof IP68- and Vandal-proof IK10-rated Housing
- Flexible Installation
- Five-year Warranty

Illumination Map

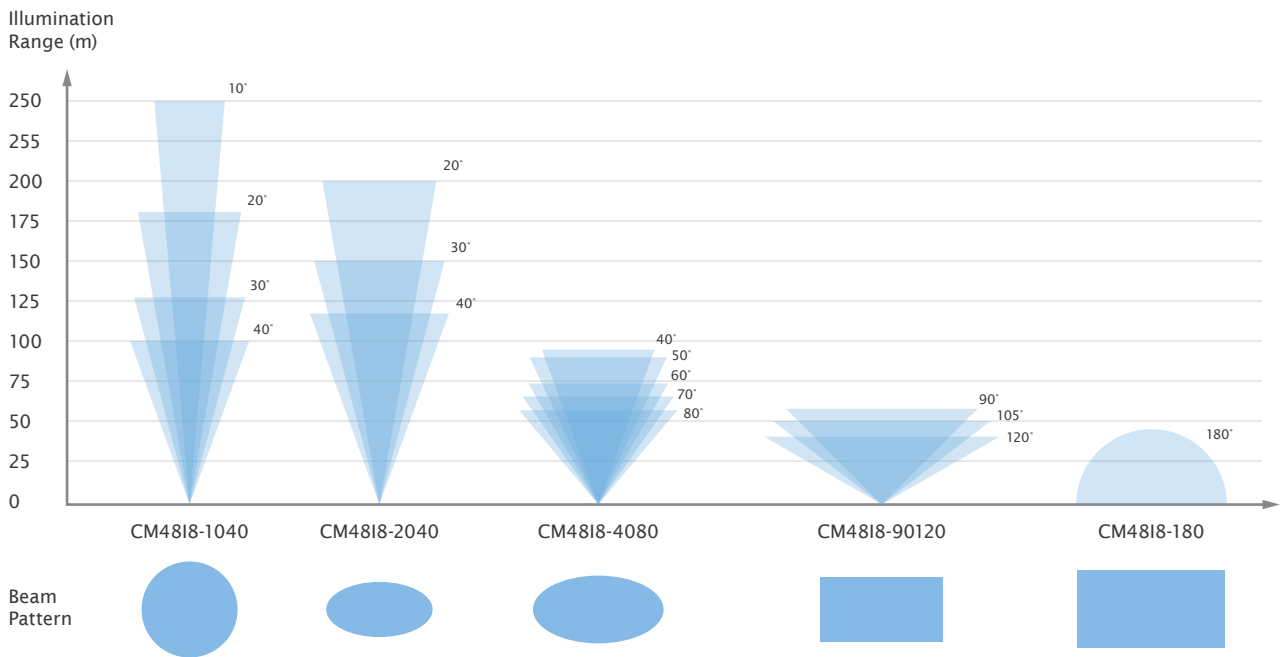

Technical Specifications

Model	CM4818-1040	CM4818-2040	CM4818-4080	CM4818-90120	CM4818-180
Product Information					
Beam Angle(Horizontal)	10° ~ 40°	20° ~ 40°	40° ~ 80°	90° ~ 120°	180°
Distance	100 ~ 250 m (328 ~ 820 ft)	120 ~ 200 m (394 ~ 656 ft)	60 ~ 90 m (197 ~ 295 ft)	45 ~ 55 m (148 ~ 180 ft)	40 m (131 ft)
Beam Pattern	Circular	Elliptical	Elliptical	Rectangular	Rectangular
LED Array	24 pcs LED				
Wavelength	850nm				
External Input	IR ON/OFF control				
External Output	Day/Night switching				
Automatic IR On/Off	Controlled by Light Sensor				
Light Sensor Sensitivity	1/5/10/30(default)/50/100% (Max. 1000 Lux) (accessed via CaMate remote/RS-485 control)				
Adjustable IR Power	20% ~ 100 % (accessed via CaMate remote/RS-485 control)				
General					
Power Input	12~24V DC ±10%, 24V AC(50/60Hz) ±10% (14.5VDC current controlled)				
Power Consumption	Max. 48W				
Operating Temperature	-40 °C ~ +60 °C (-40 °F ~ +140 °F)				
Working Temperature	-50 °C ~ +60 °C (-58 °F ~ +140 °F)				
Dimensions	220 x 160 x 73 mm (8.6 x 6.3 x 2.9 inch)				
Weight	2.1 kg				

Technical Specifications

Model	CM4818-1040	CM4818-2040	CM4818-4080	CM4818-90120	CM4818-180
Cable Length	0.75 m (2.46 ft) UL AWM				
Casing	IP68, IK10				
Safety Certifications	IEC 62471, EN 50130-4, CE: EN61000-6-3, EN60598-1, EN60598-2-5, FCC ClassB, EN60529				
Humidity	90%				
Warranty	5 years				

Included Accessories

Bracketry	U-Type Bracket (134 × 34 × 81.5 mm)
-----------	-------------------------------------

Optional Parts







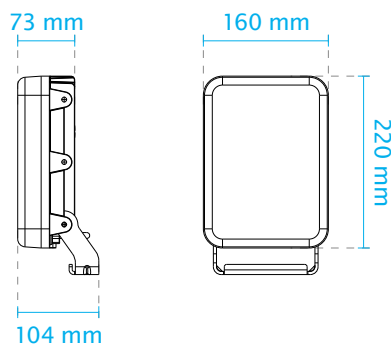

Ordering Information - Optional LED Source (Power Input 24V DC/AC ±10%)

940nm	CM4819-1040	CM4819-2040	CM4819-4080	CM4819-90120	-
White LED 5000K	CM48W5-1040	CM48W5-2040	CM48W5-4080	CM48W5-90120	-

Dimensions



Compatible Accessories

Bracket			Mounting Kit		
					
AM-219 L-Bracket for Dual CaMate Illuminators	CMA-B01 L-Bracket for Single CaMate Illuminator	CMA-B03 U-Type Bracket for Single CaMate Illuminator	CMA-B04 Wall-Mount Kit for Single/Dual CaMate Illuminator	CMA-B05 Wall-Mount Kit for Dual/Triple CaMate Illuminator	CMA-B06 Wall-Mount Kit for Dual/Triple CaMate Illuminator
Alignment Kit	Remote Controller	Power Supply			
					
CMA-A01 Laser Alignment Kit	CMA-E01	HLG-60H-24 60W Single Output Switching Power Supply			